

Semi Welded Plate Heat Exchanger Product Manual for Refrigeration

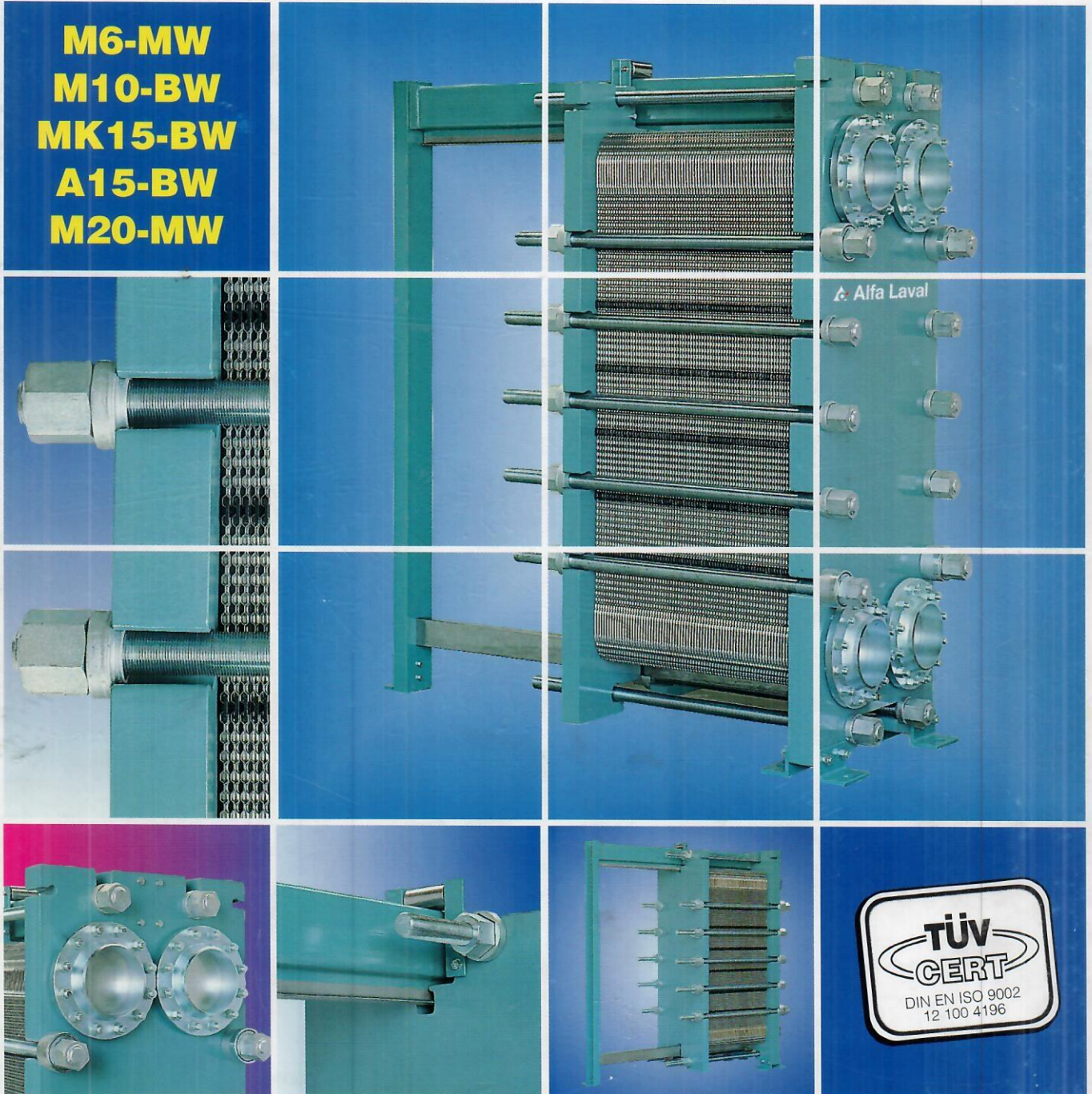

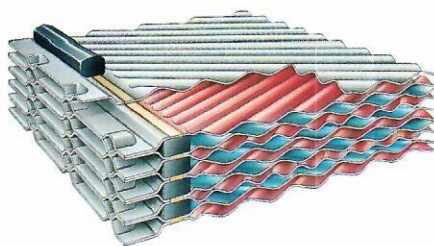
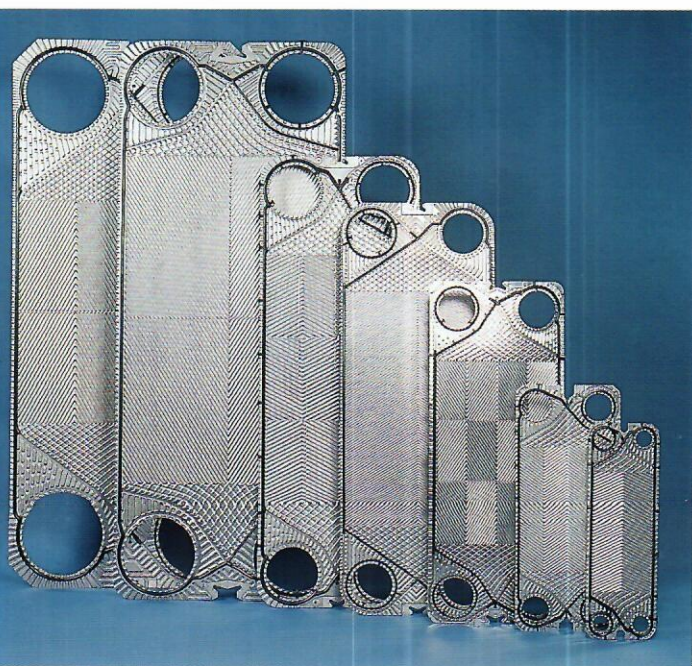

Fig. 1 The channels for the refrigerant and the brine are sealed by laser welds and gaskets.



Fig. 2 SWPHE as an evaporator in a brewery installation.

Fig. 3 The complete range of Alfa Laval plates for SWPHE.



Semi Welded Plate Heat Exchanger

The Alfa Laval Semi Welded Heat Exchanger (SWPHE) alternates welded channels and traditional gasketed channels.

The refrigerant flows in welded channels and the only gaskets in contact with the refrigerant are two circular porthole gaskets between the welded plate pairs. These gaskets are made from highly resistant materials, attached for easy replacement by a glue-free construction.

The secondary medium flows in channels sealed by traditional elastomer gaskets. Double sealing and corrosion resistant plate materials prevent intermixture of media, the absence of pressure-retaining seal welds and a flexible, yet vibration-resistant design.

Applications

The Alfa Laval Semi Welded Heat Exchangers are used as evaporators and condensers for refrigeration systems in a whole series of applications, eg:

- Dairy, brewery and vineyard production
- Marine
- Fishing vessels and fish processing
- Slaughterhouses
- Chemical and pharmaceutical industries
- Ice manufacturing, ice-skating rinks
- Cold and frozen storage
- Food retail outlet

When the gasketed side is food approved it could be used in direct cooling of food liquids, eg. NH₃/beer, juice or water.

Other application like Heat Pumps, Organic Rankine Cycles and Absorption Systems could also request SWPHE for different duties.

Features

The SWPHE is very flexible and variable and can be arranged in Twin or two-units-in-one design, e.g. Desuperheater/Condenser, Oilcooler/Evaporator. These features give us the possibility to manufacture two duties in one frame at a lower cost, smaller volume and shorter footprint.

Disassembling and Assembling Possibilities

The plate heat exchanger concept allows the SWPHE to be opened and reclosed several times.

This makes assembly on site piece by piece possible, which is an advantage when transportation space is limited. It also allows opening the SWPHE for service. Since all connections are normally located at one end, no pipework removal for service is necessary. The heat transfer surface could also be augmented if the capacity is increased or if the temperature program is changed.

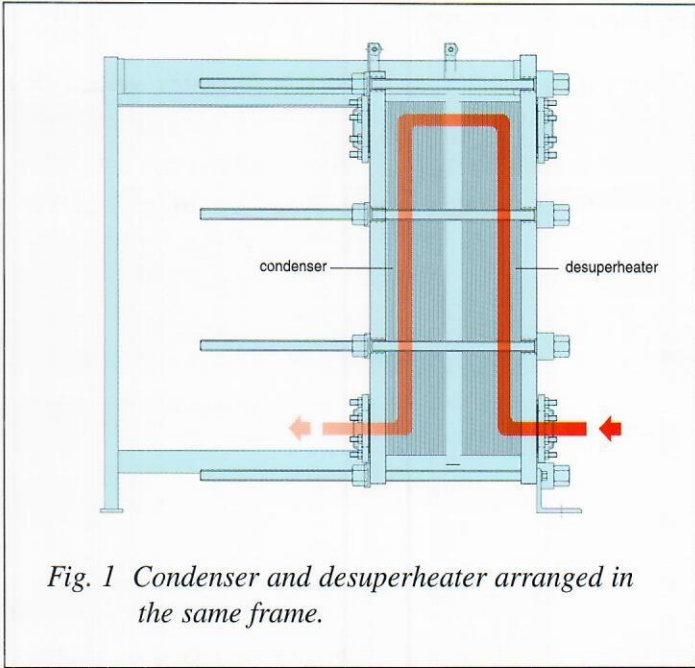

Fig. 1 Condenser and desuperheater arranged in the same frame.

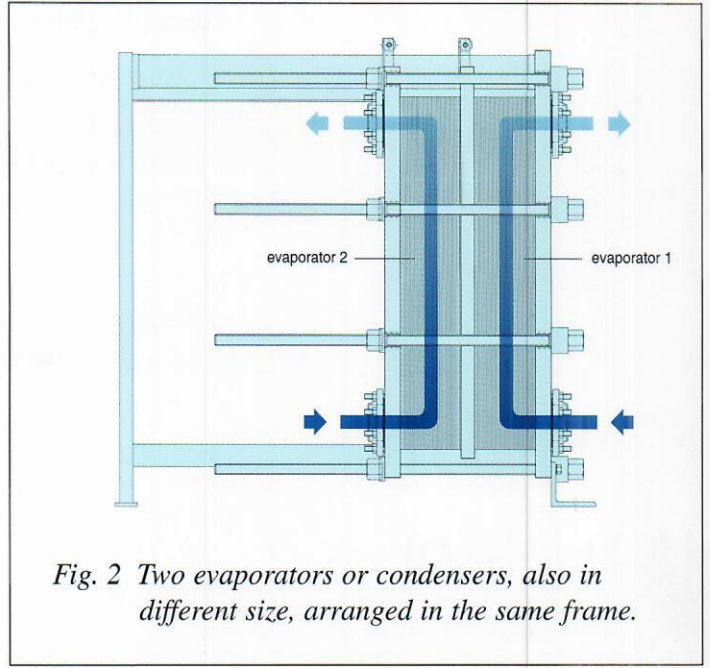

Fig. 2 Two evaporators or condensers, also in different size, arranged in the same frame.

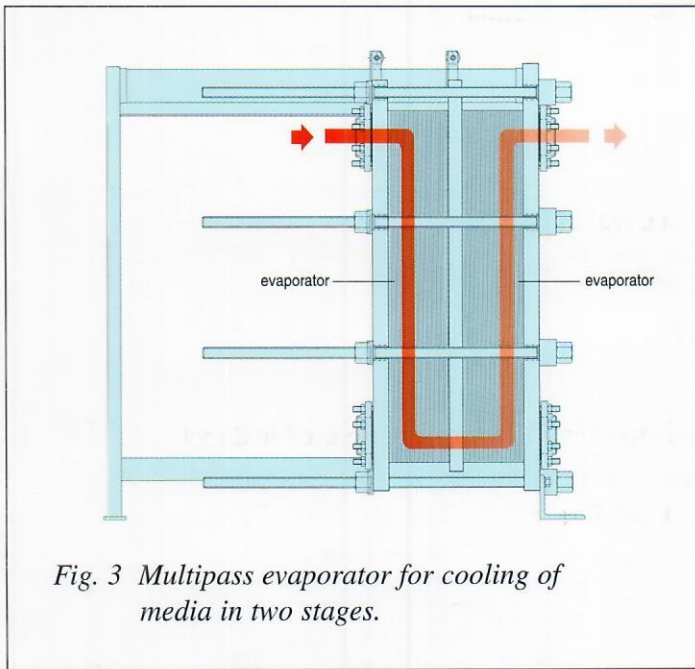

Fig. 3 Multipass evaporator for cooling of media in two stages.

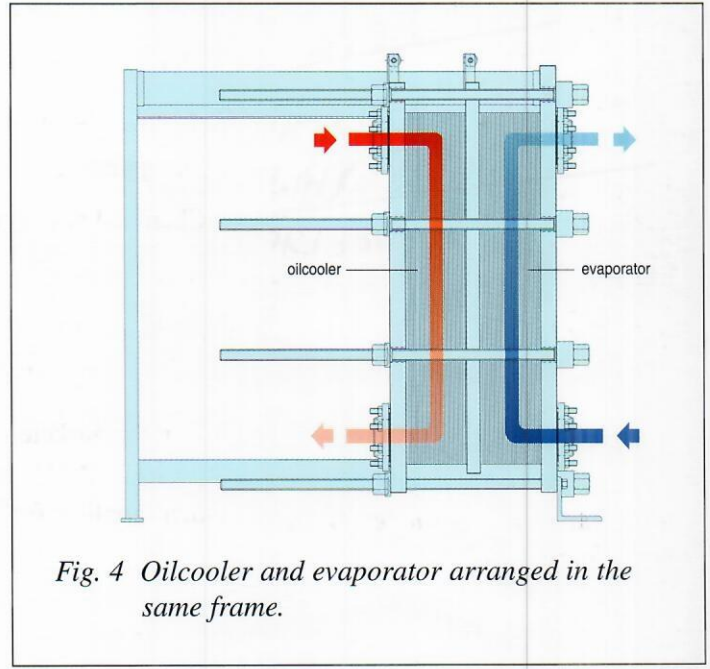

Fig. 4 Oilcooler and evaporator arranged in the same frame.

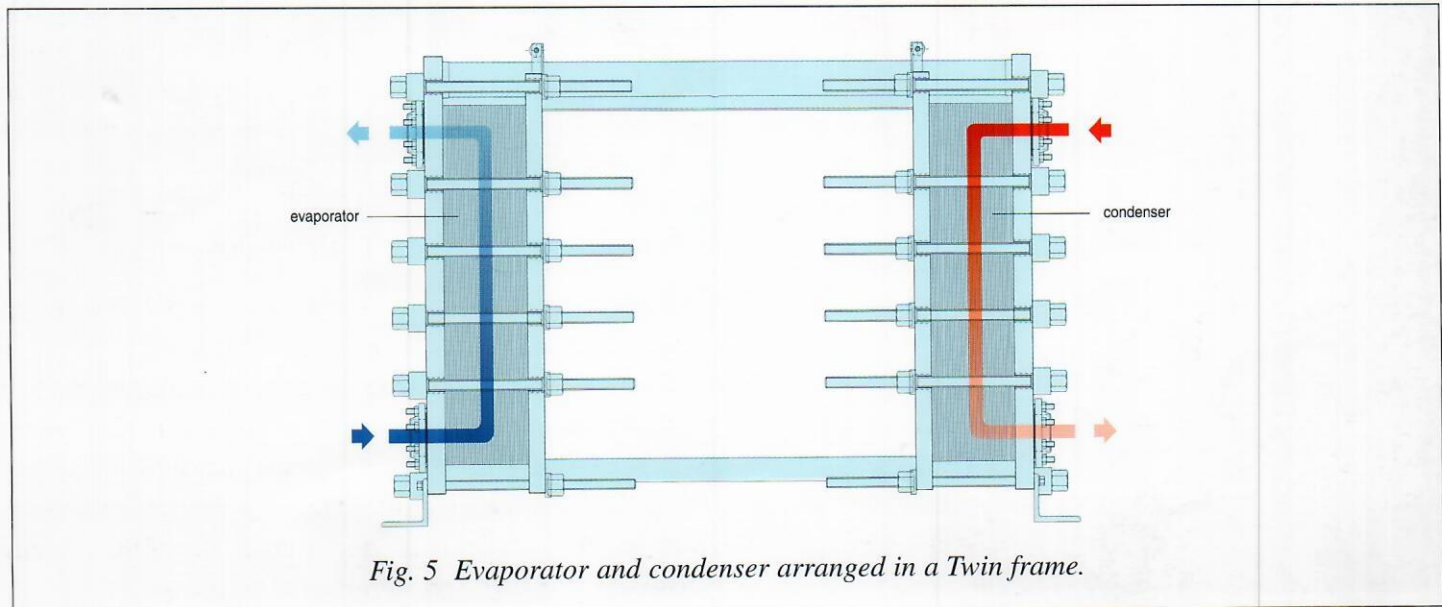

Fig. 5 Evaporator and condenser arranged in a Twin frame.



Fig. 4 SWPHE becomes more compact and request a lower filling of refrigerant for the same duty.

Advantages

The plate heat exchanger concept, with flow-through channels formed by corrugated plates and the heat transfer taking place through the thin plates, is an extremely efficient heat exchange technique.

The turbulent flow, coupled with low fouling factors and high heat transfer coefficients, means that it is possible to operate with a small temperature difference in evaporating and chilled water temperatures. This in turn provides a good operational economy with high C.O.P. values.

It also means that a Semi Welded Plate Heat Exchanger becomes much more compact than a Shell & Tube Heat Exchanger for the same duty. The practical advantages are:

- lower weight
- smaller space requirements
- lower refrigerant filling.

Characteristics of cassettes

The cassettes are designed in three different angles of corrugation:

Low Theta = for higher flow and high temperature approach

Medium Theta = for medium flow and medium temperature approach

High Theta = for lower flow and low temperature approach

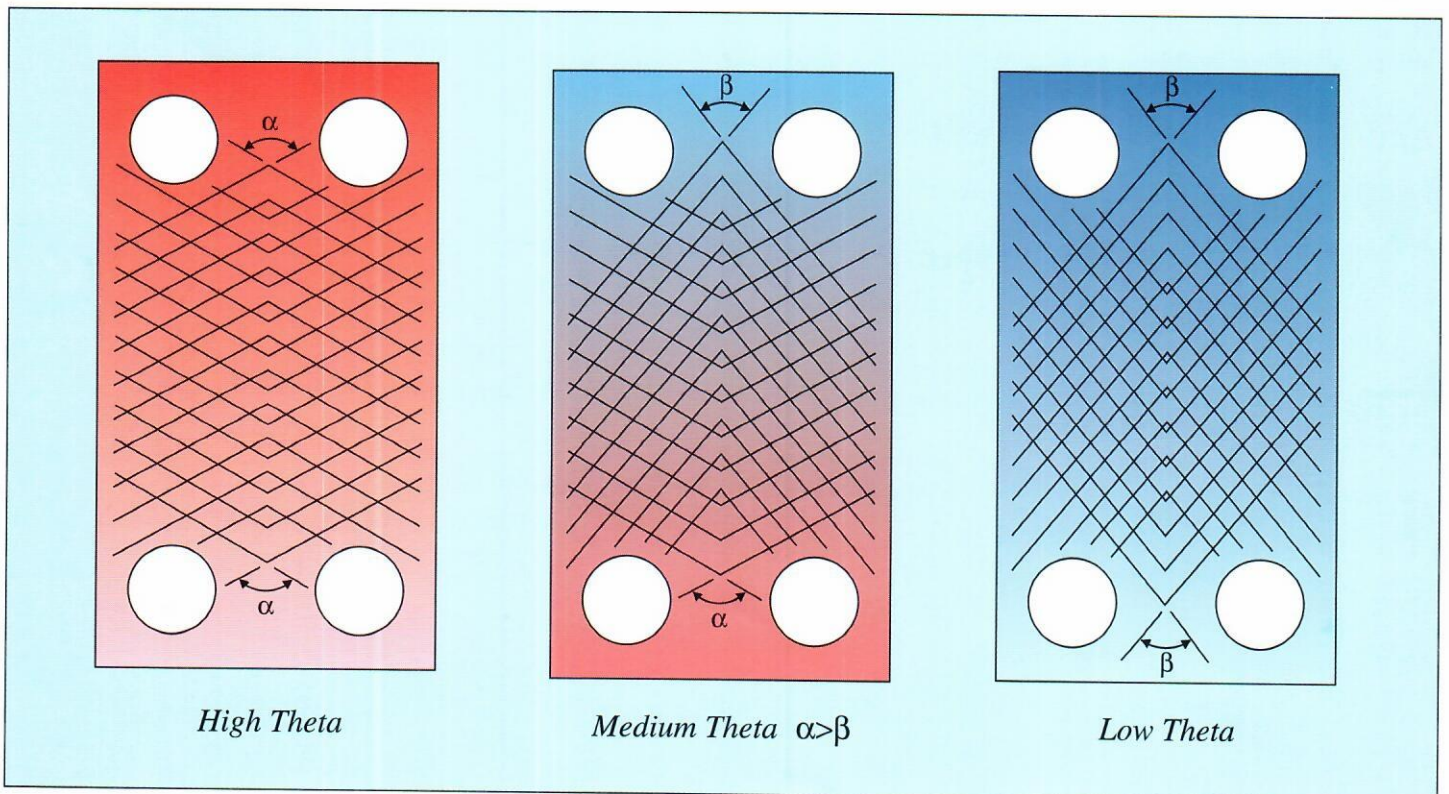

The Medium Theta cassette is a mixture of High and Low Theta plates. New plate cassettes in alternative material can be inserted when more corrosive cooling water is introduced.

The following plate materials are standard:

- AISI 304
- AISI 316
- Titanium

Mechanical Aspects and Freezing

The SWPHE is not sensitive to temperature shocks, and there is no vibration due to the small distance between the support points.

There is no pressure retaining welds in the SWPHE. Due to the turbulent flow, freezing risks are small, but the flexible design will accommodate expansion, and no damage will be caused should freezing occur.

Leak Detection

Intermixing of media is not possible with the double sealing. The diagonal gaskets form the weakest components, and any leak will occur through a gasket, which is externally detectable for both media sides.

The Alfa Laval SWPHE is designed with no internal welds, and hence there will be no internal leaks.

Guarantee and Maintenance

The guarantee for the SWPHE is 12 months from the delivery date. The guarantee is not valid if the unit is operated under conditions other than those specified. It is very important that the unit is installed and set up according to the instructions.

Gasket replacement of SWPHE will be recommended for evaporator/condenser at an interval of 5/4 years for ring gaskets and 10/8 years for field gaskets.

In case of fouling growth, the SWPHE can be cleaned by CIP on site. A mobile CIP could be docked to the unit and then circulate CIP liquid.

For more thorough service the cassettes can be sent in for total reconditioning, where the gaskets will be removed, the cassette cleaned and new gaskets provided.

Approvals and Pressure Vessel Codes

Local countries limitations, requirements and additional based on NH3 services.

Country of destination	Pressure vessel authority	Approval required	Preapproval available	Accepted design code	Inspection by	Design pressure		Design temperature		Test pressure DP x coeff.
						LP bar minimum	HP bar minimum	LT °C minimum	HT °C maximum	
Sweden	SAQ	Yes	Yes	SA	SA	13	23	-45	120	1,3
Norway	KK		No	SA	SA			-45	120	1,3
Finland	INSPECTA	Yes	Yes	SA/TÜV	SA	20,8	20	-45	120	1,3
Denmark	AT	Yes	Yes	SA	SA	24	24	-45	120	1,3
Germany	TÜV	Yes	Yes	TÜV	SA/Self	13	23	-45	120	1,3
Greece			No	SA	SA O.R.			-45	120	1,3
Turkey			No	SA/TÜV	SA O.R.			-45	120	1,3
Netherlands	Stoomweezen	Yes	No	SA	SA	15	23,5	-45	120	1,4
Belgium	AIB-Vincotte		No	SA	SA O.R.			-45	120	1,3
France	Service de Min	PV/ch>80bl	No	SA	SA O.R.			-45	120	1,3
Spain			No	SA	SA O.R.			-45	120	
U.K.	BS		No	ASME/SA		10,5	17,5	-45	120	1,35
Austria	TÜV/ÖTÜV	Yes	ÖTÜV partly	TÜV/ÖTÜV	SA	17,3	22	-45	120	1,5
South Africa			No	SA/TÜV	SA O.R.			-45	120	1,3
Italy	ISPESL	Yes, Vtot>25l	Yes	ISPESL	SA/ISPESL	15	22	-45	120	1,2
Russia	GOOSP	Yes	Yes	SA	SA			-45	120	1,3
Czech Rep.			No	SA	SA O.R.			-45	120	1,3
Slovakia			No	SA	SA O.R.			-45	120	1,3
Hungary			No	SA	SA O.R.			-45	120	1,3
Romania	ISCIR	Yes	Partly	SA	SA			-45	120	1,3
Poland	UDT	Yes	Partly	SA	SA			-45	120	1,3
USA	ASME	Yes	Not appl.	ASME VIII	ASME			-45	120	1,5
Canada	CZA	Yes	Not appl.	ASME VIII	ASME			-45	120	1,5
Brazil			No	SA/ASME	SA O.R.			-45	120	1,3
India			No	SA/TÜV	SA O.R.			-45	120	1,3
Japan	KHK	Yes	Yes	KHK	KHK	13		-45	120	1,3



Fig. 5 Due to flexible design, no damage will occur when freezing.

O.R. = on request / LP = low pressure / HP = high pressure / LT = low temperature / HT = high temperature / DP = design pressure

The low and high temperatures are gasket limited temperatures.

Marine approvals are on request.

Frame and plate guide

Models		M6-MW	M10-BW	MK15-BW	A15-BW	M20-MW
FGR						
Max design press. / Test press.	bar	16/21	16/21	16/21	16/21	16/21
Standard temperature	°C	-10/120	-10/120	-10/120	-10/120	-10/120
Low temperature	°C	-45/50	-45/50	-45/50	-45/50	-45/50
FDR						
Max design press. / Test press.	bar	25/33	25/33	25/33	25/33	25/33
Standard temperature	°C	-10/120	-10/120	-10/120	-10/120	-10/120
Low temperature	°C	-45/50	-45/50	-45/50	-45/50	-45/50
AISI 304 - 0,6 mm						
Max design press. / Test press. gasket side	bar	on request	27/36	25/33	on request	on request
Max design press. / Test press. welded side	bar	on request	31/41,5	31,8/42	on request	on request
Cassette weight	kg	on request	3,00	5,64	on request	on request
AISI 316 - 0,6 mm						
Max design press. / Test press. gasket side	bar	23/31	27/36	25/33	on request	20/26
Max design press. / Test press. welded side	bar	31/41,5	31/41,5	31,8/42	on request	24/31
Cassette weight	kg	1,80	3,00	5,64	on request	10,1
AISI 316 - 0,7 mm						
Max design press. / Test press. gasket side	bar	on request	on request	on request	20/26	24/31
Max design press. / Test press. welded side	bar	on request	on request	on request	25/33	27/36
Cassette weight	kg	on request	on request	on request	9,20	11,6
Titanium - 0,6 mm						
Max design press. / Test press. gasket side	bar	20/26	20/26	16/21	12/16	16/21
Max design press. / Test press. welded side	bar	24,5/32	25/32	24/32	16/21	16/21
Cassette weight	kg	1,10	1,75	3,28	4,80	6,10
Titanium - 0,7 mm						
Max design press. / Test press. gasket side	bar	on request	on request	21/28	on request	20/26
Max design press. / Test press. welded side	bar	on request	on request	28/36	on request	24/31
Cassette weight	kg	on request	on request	3,79	on request	6,90
Titanium - 0,8 mm						
Max design press. / Test press. gasket side	bar	on request	on request	on request	20/26	24/31
Max design press. / Test press. welded side	bar	on request	on request	on request	25/33	27/36
Cassette weight	kg	on request	on request	on request	6,30	7,90
Area / Plate	m ²	0,124	0,24	0,46	0,75	0,85
Volume / Channel	l	0,40	0,63	1,27	1,70	3,67
Free channel	mm	2,80	2,40	2,50	2,30	4,00

The low and high temperatures are gasket limited temperatures.

The design pressure of the unit is limited to the frame.

Gasket selection guide

Refrigerant on welded side

Refrigerant mixed with normal compressor oil – type mineral oil with low aromatic contents (synthetic oils have to be checked).

For special operation cases like:

- temporary high temperature changes
- cleaning by CIP at high temperature
- other media than R22, NH3 or water like brines.

Please contact Alfa Laval technical support.

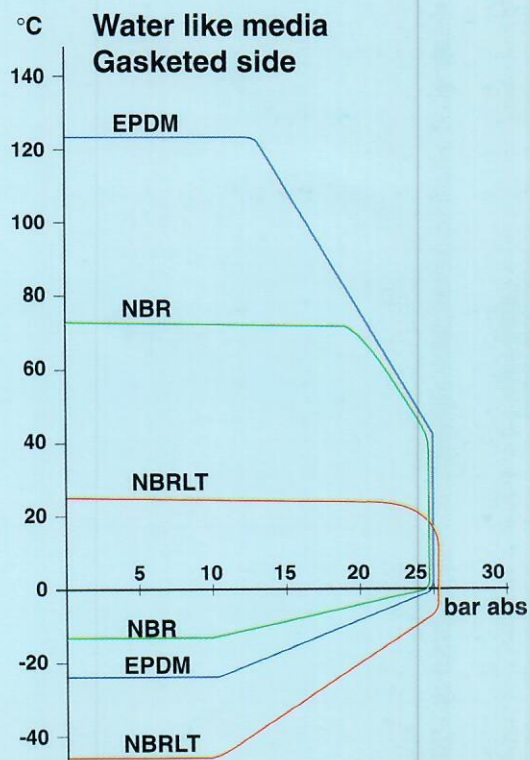
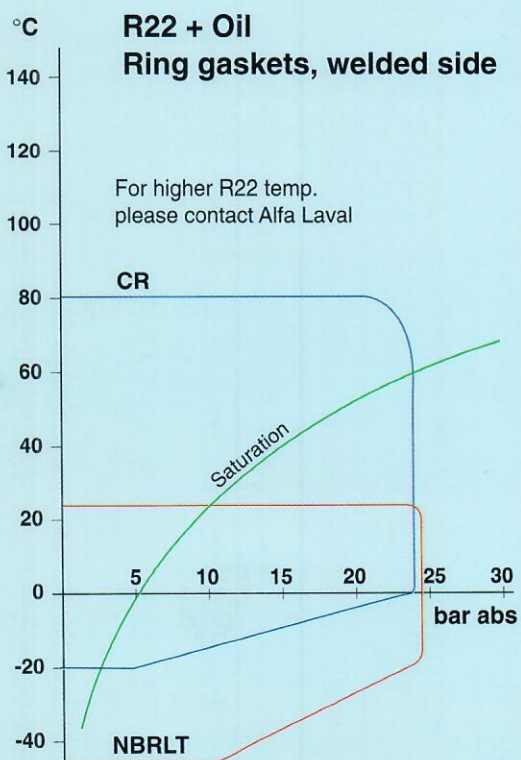
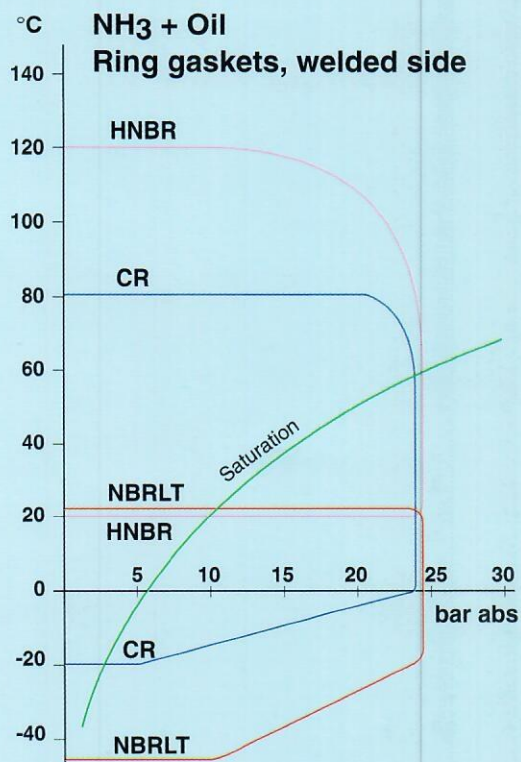

N° of cassetts			20	30	40	50	60	70	80	90
Cooling tower	Qn	kW	560	850	1150	1450	1750	2050	2250	2400
	Ti = 29,5°C	Wn	m³/h	87,7	133,1	180,1	227,0	274,0	321,0	344,5
	Tc = 38,5°C	Δp H ₂ O	bar	0,68	0,69	0,71	0,74	0,77	0,81	0,74

City water	Qn	kW	570	860	1170	1470	1770	2080	2350	2500	
	Ti = 15°C	Wn	m³/h	75,3	113,6	154,5	194,2	233,8	274,4	310,4	330,2
	Tc = 25°C	Δp H ₂ O	bar	0,53	0,53	0,55	0,57	0,59	0,62	0,64	0,61

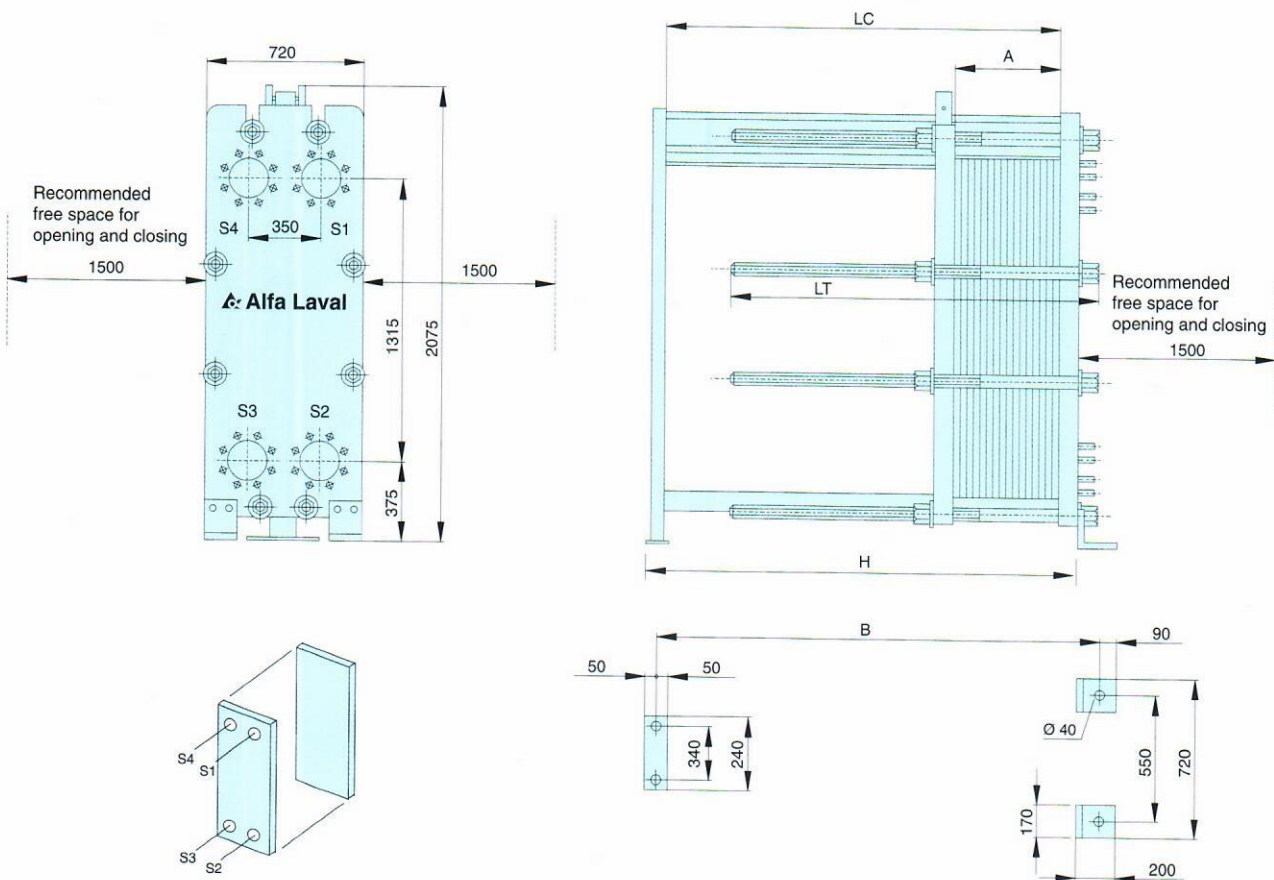

N° of cassetts			< 38	< 65	< 118	< 171	< 224	< 250
DIMENSIONS	A	mm	228	390	708	1026	1644	1500
	Lc	mm	900	1200	1800	2400	3000	3300
	Lt	mm	750	1050	1650	2250	2850	3150
	H	mm	1035	1335	1935	2535	3135	3435
	B	mm	1095	1395	1995	2595	3195	3495
	Connection	mm	DN 150	DN 150	DN 150	DN 150	DN 150	DN 150
DATA	V _{H₂O}	dm³	34	110	206	252	342	374
	V _{NH₃}	dm³	38	114	210	258	346	380
	W	Kg	2009	2560	3230	4080	4480	4810

S₁ Outlet water
S₂ Inlet water
S₃ Outlet refrigerant

S₄ Inlet refrigerant
Ti Water inlet temperature
Tc Condensing temperature

Qn Nominal capacity
Wn Water nominal flow
Δp H₂O Water pressure drop

W Weight
V H₂O Water volume
V NH₃ Ammonia volume

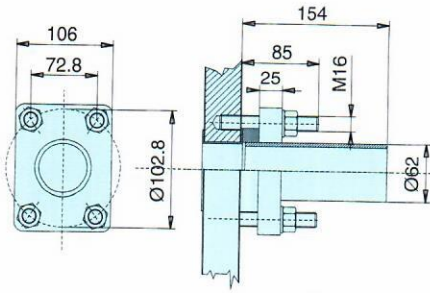

Fig. 1 Connections S1, S2, S3 and S4 for M6-MW. Design pressure 16/25 bar

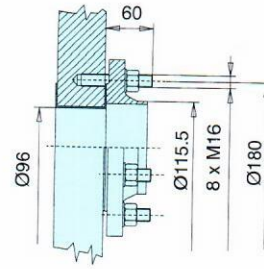

Fig. 2 Connections S1, S2, S3 and S4 for M10-MW. Design pressure 16 bar

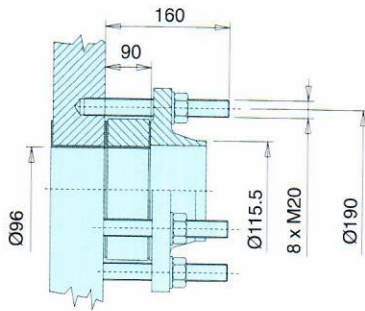

Fig. 3 Connections S1, S2 for M10-BW. Design pressure 25 bar

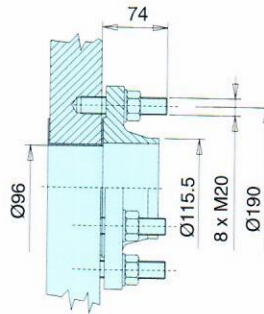

Fig. 4 Connections S3 and S4 for M10-BW. Design pressure 25 bar

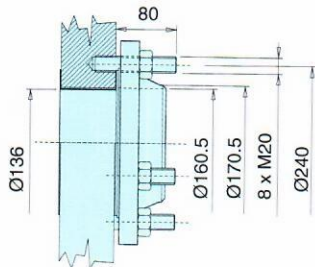

Fig. 5 Connections S1, S2, S3 and S4 for MK15-BW and A15-BW. Design pressure 16 bar

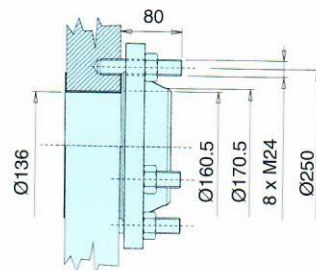

Fig. 6 Connections S1, S2, S3 and S4 for MK15-BW and A15-BW. Design pressure 25 bar

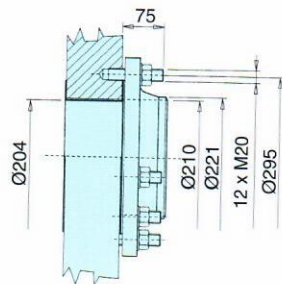

Fig. 7 Connections S1, S2, S3 and S4 for M20-MW. Design pressure 16 bar

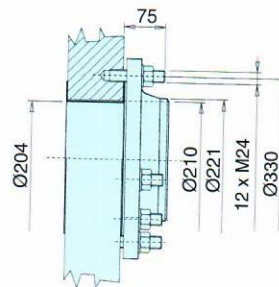

Fig. 8 Connections S1, S2, S3 and S4 for M20-MW. Design pressure 25 bar

Alfa Laval SWPHE will be delivered with counter flanges on all connections.